

**WARNING**

**DISCONNECT POWER BEFORE RELAMPING OR WIRING THE FIXTURE.  
READ ALL INSTRUCTIONS COMPLETELY BEFORE STARTING INSTALLATION.**

**CAUTION**

- TO AVOID THE RISK OF FIRE OR SHOCK, FIXTURE MUST BE INSTALLED IN COMPLIANCE WITH ALL APPLICABLE NATIONAL AND LOCAL ELECTRICAL/BUILDING CODES.
- INSTALLATION AND MAINTENANCE OF THIS UNIT REQUIRES AN ELECTRICIAN OR CERTIFIED FACTORY TRAINED TECHNICIAN.
- If an existing fixture is being replaced, remove it and note to which of the wires in the outlet box the fixture was attached. DO NOT SEPARATE ANY OTHER WIRES THAT MAY BE IN THE BOX. DO NOT DAMAGE THE INSULATION OF OLDER WIRING. In regular circumstances the BLACK wire will be the "Hot" lead and the WHITE wire will be the "Neutral" or "Common" lead. A GREEN or BARE COPPER wire is the "Ground". In older buildings it is always good practice to reconfirm the polarity of the wiring.

**NOTICE**

- The important safeguards and instructions outlined on this sheet cannot cover all possible conditions and situations that may occur. It must be understood that common sense, caution and care are factors that cannot be built into any product. Caution and care must be supplied by the person(s) installing, operating and caring for this lighting fixture.
- This fixture is designed to be mounted on a correctly installed standard round or octagon box or a through wiring box with a plaster frame. The box must be securely mounted to the structure of the building. The crossbar and hardware supplied should be used. Directly mounting the fixture to the outlet box may make it impossible to correctly align the fixture.

**FIXTURE PREPARATION**

1. Remove the fixture, parts and parts bag(s) from the carton.

**NOTICE:**

Before discarding the carton, double check to make certain that all parts are found.

2. This fixture is supplied with a 3-piece stem. There is one 6" section, one 12" section and one 18" section. This feature allows the fixture to be mounted with NO stem OR a stem from 6" up to 36" in length in 6" increments.
3. This fixture is supplied with a swivel. By rotating the canopy the fixture may be mounted to an angled ceiling of up to 24 degrees

**FIXTURE INSTALLATION**

1. Determine the overall desired length of the fixture.  
For general convenience the fixture is shipped with the leads threaded through the stems.  
If the stems are rearranged or additional stems are added, tape the ends of the leads to a stiff wire (coat hanger) to aid in pulling them through the stems.
2. Attach the crossbar to the outlet box.  
(The green screw should face the floor)
3. Fasten the ground wire to the green or bare copper wire in the outlet box or to the green screw on the crossbar.

**WARNING**

Never fasten the ground wire to the black or "hot" wire!  
Failure to follow this instruction could result in serious injury or death!

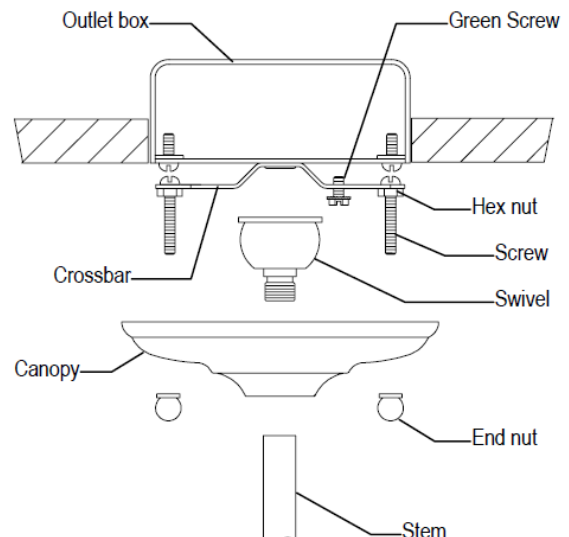

- Fasten the white fixture lead to the white wire in the outlet box.  
Fasten the wires together with an approved fastener (wire nut). Starting about 1" below the fastener, tightly wrap the connection with electrical tape so that the connection seals the end of the fastener.

**⚠ WARNING**  
Make sure that there is no exposed wire or strands that could cause a dangerous short circuit !

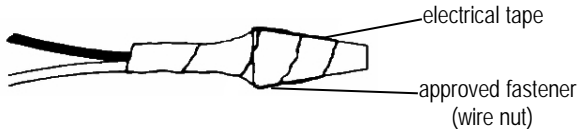

- Connect the black fixture lead to the black wire in the outlet box. Fasten the joined wires as in step 4.
- Using the end nuts, fasten the fixture to the outlet box. Rotate and align the canopy as necessary.
- Install the lamps ( light bulbs). NOTE: This fixture is rated for Max 75 watt type A lamp.

**⚠ WARNING**  
DO NOT EXCEED RECOMMENDED WATTAGE!

- Remove the retaining ring from the bottom of the shade.  
Place the glass lens into the retaining ring and bend the tabs down to hold it in place.
- Reinstall the retaining ring.
- Restore power to circuit at breaker or fuse box.

