

**Tools Required:** Flathead screwdriver, Phillips screwdriver, pliers, wire cutters, wire strippers, electrical tape, safety glasses.  
**Bulb Recommended:** (3) Medium Base Decorative Filament 60W bulbs (provided), Maximum 100W, Alternate bulb (3) 23W CFL Maximum.  
**Estimated Assembly Time:** 20-30 minutes  
**Preparation:** Identify and inspect all parts before beginning installation. Check package content list and diagrams below to be sure all parts are present. If any parts are missing or damaged, do not attempt to assemble, install, or operate the fixture. Contact customer service for replacement parts.

**⚠ Warnings and Cautions**

Turn off electricity at circuit breaker or main fuse box before installation. Consult a licensed electrician if in doubt.  
These instructions are provided for your safety. It is very important you read them completely before installing the fixture. We strongly recommend that a licensed, professional electrician perform the installation.  
Disconnect fixture from power source before replacing bulbs. Make sure bulbs are given sufficient time to cool before removal. Do not subject glass parts to any shock while in operation or shattering may result.

**Package Contents**

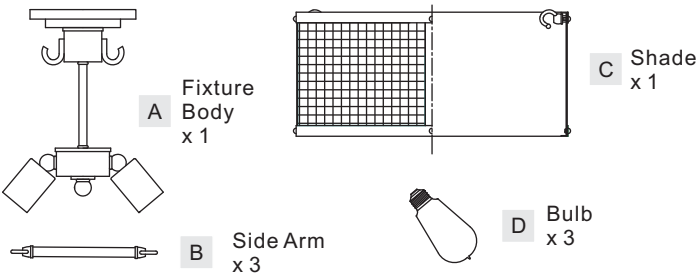

**Hardware Contents**

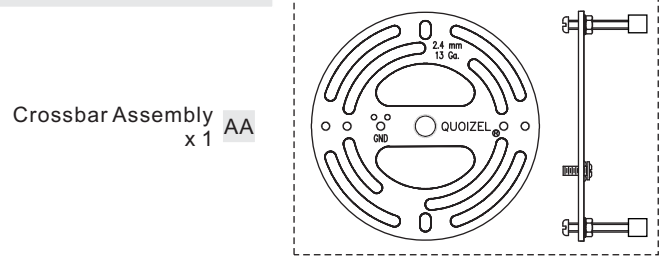

**STEP 1 - Install Crossbar Assembly**

A. Pass the supply wires through the Crossbar Assembly (AA). Attach the Crossbar Assembly (AA) to the Outlet Box with the head of the Green Ground Screw facing you. Secure it with Outlet Box Screws (not included). Tighten until snug.

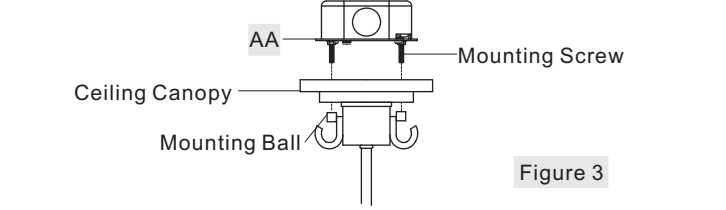
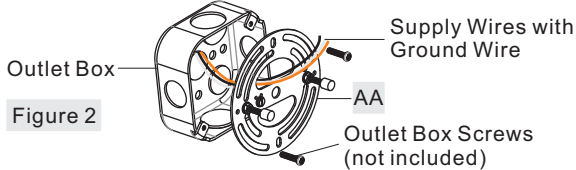

**STEP 2 - Wire Connections**

A. Use standard wire connectors (not included) to make all wire connections. (Connectors are not included with fixture.) Twist connectors until wires are tightly joined together. Wrap each connection with approved electrical tape and carefully stuff all the connected wires into the Outlet Box.

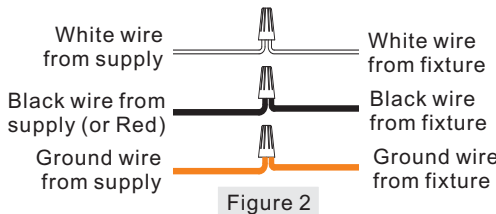

**STEP 4 - Install Shade, Fixture Body and Side Arm together**

A. Place one Loop on Side Arm (B) hook on the Hook on the Fixture Body (A), the other Loop on the Side Arm (B) hook on the Hook on the Shade (C).

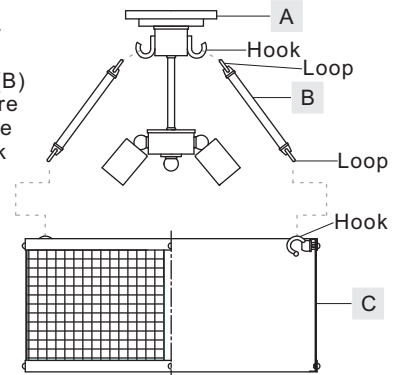

**STEP 3 - Attach Fixture Body to Mounting Screw**

A. Remove Mounting Balls from the Crossbar Assembly (AA).  
B. Place the Ceiling Canopy of the Fixture Body (A) over the Mounting Screws and secure with Mounting Ball (B). Hand tighten until snug.

**STEP 5 - Install Bulb**

A. This fixture uses standard bulb with medium screw base. Maximum 100 watts.  
B. Insert bulb and screw snugly into place.

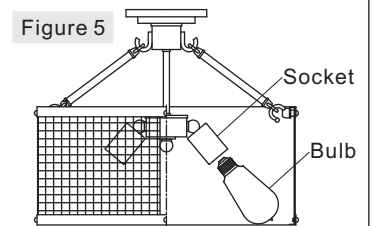

Your fixture is now assembled and ready to use. Enjoy!

WLR1716MB

FINISH: MOTTLED BLACK

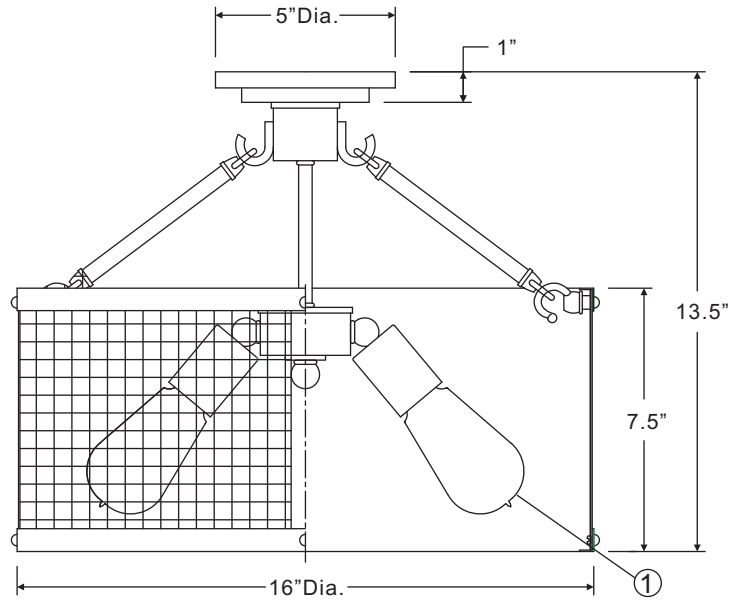
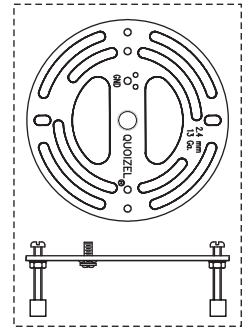

(3) Medium Base  
Decorative  
Filament 60W  
bulbs (provided),  
Maximum 100W.

NOTE: ALL DIMENSIONS ARE ROUNDED UP TO THE NEAREST 1/2"

NO.	PART NUMBER	REPLACEMENT PART DESCRIPTION	REQ.
1	I1101EC	VINTAGE BULB	3

Thank you for purchasing a Quoizel product.  
Need assistance with parts or assembly? Call Quoizel customer service at 1-631-273-2700  
or visit us on-line at [www.quoizel.com](http://www.quoizel.com)