

Please go to [www. quozel. com](http://www. quozel. com) for product cleaning tips. Go to the **Care + Maintenance** selection.

**Tools Required:** Flathead screwdriver, Phillips screwdriver, pliers, wire cutters, wire strippers, electrical tape, safety glasses.

**Light Source:** (5) Medium Base 60W Maximum, Alternate bulb (5) 13W CFL

**Estimated Assembly Time:** 30-45 minutes

**Preparation:** Identify and inspect all parts before beginning installation. Check package content list and diagrams below to be sure all parts are present. If any parts are missing or damaged, do not attempt to assemble, install, or operate the fixture. Contact customer service for replacement parts.

### **Warnings and Cautions**

Turn off electricity at circuit breaker or main fuse box before installation. Consult a licensed electrician if in doubt.

These instructions are provided for your safety. It is very important you read them completely before installing the fixture. We strongly recommend that a licensed, professional electrician perform the installation.

Disconnect fixture from power source before replacing bulbs. Make sure bulbs are given sufficient time to cool before removal. Do not subject glass parts to any shock while in operation or shattering may result.

### **Package Contents**

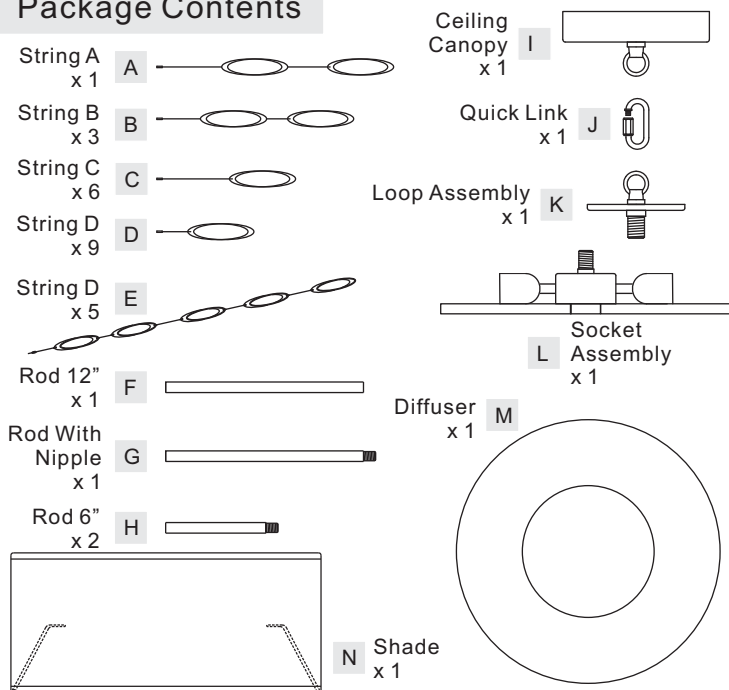

### **Hardware Contents**

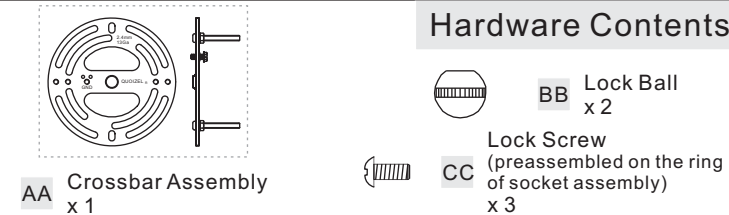

#### **STEP 1 - Install Shade**

A. Remove Lock Screws (CC) on the Ring of Socket Assembly (L). Attach the Shade (N) to the Socket Assembly (L) and secure with the Lock Screws (CC). Hand tighten until snug.

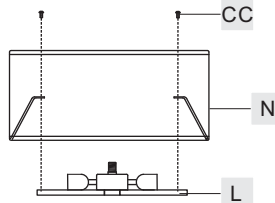

Figure 1

#### **STEP 2 - Assemble the Rods and the Loop Assembly**

A. Determine the Rods (F/G/H) to be assembled to the Socket Assembly (L) according to your hanging height.

B. Pass the supply wires and ground wire through the chosen rods (F/G/H) and the Socket

(K). Thread the Socket Assembly (K), the chosen Rods (E/F/G) and the Loop Assembly (J) together as shown. Hand tighten until snug.

Suggested rods for Ceiling height :  
8' ceiling : use (1) 6" rod and (1) 12" rods  
9' ceiling : use (1) 6" rod and (2) 12" rods

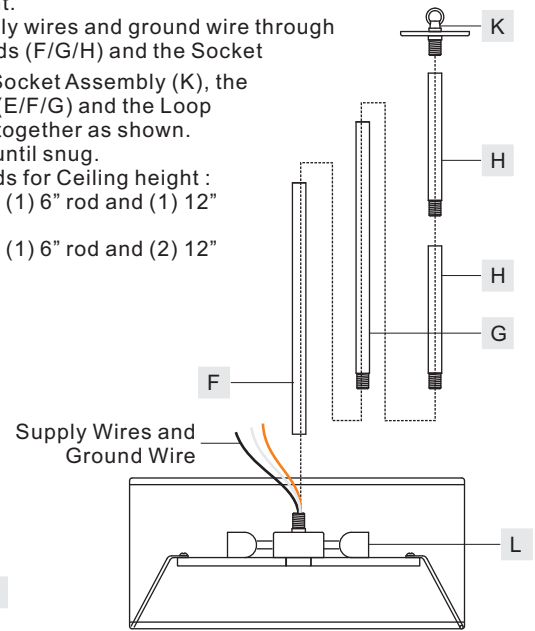

Figure 2

#### **STEP 3 - Attach Quick Link**

A. Pass the Supply Wires and Ground Wire through the Quick Link (J) and the Ceiling Canopy (I). Connect the Loop Assembly (L) to the Ceiling Canopy (I) with the Quick Link (J).

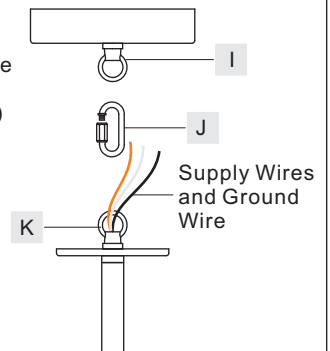

Figure 3

**Thank you for purchasing a Quozel product.**  
**Need assistance with parts or assembly? Call Quozel customer service at 1-631-273-2700**  
**or visit us on-line at [www. quozel. com](http://www. quozel. com)**

#### STEP 4 - Install Crossbar

- A. Attach the Crossbar Assembly (AA) to the Outlet Box with the head of the Green Ground Screw facing you. Secure it with Outlet Box Screws (not included). Tighten until snug.

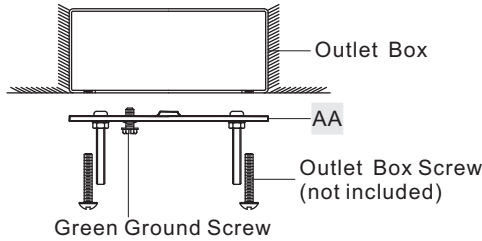

Figure 4

#### STEP 5 - Wire Connections

- A. Use standard wire connectors (not included) to make all wire connections. (Connectors are not included with fixture.) Strip and prepare wire ends according to instructions supplied with connectors.  
 B. Connect White Supply Wire from the Outlet Box to Ribbed side Wire from fixture.  
 C. Connect Black (or Red) Supply Wire from the Outlet Box to Smooth side Wire from fixture.  
 D. Connect Ground Wire from the Outlet Box to Ground Wire from fixture.  
 E. Twist connectors until wires are tightly joined together.  
 F. Wrap each connection with approved electrical tape and carefully stuff all the connected wires into the Outlet Box.

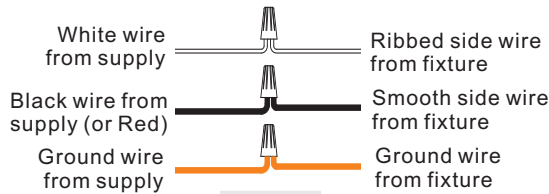

Figure 5

#### STEP 6 - Attach Ceiling Canopy to Mounting Screw

- A. Place the Ceiling Canopy (I) over the Mounting Screws and secure with Lock Balls (BB). Hand tighten until snug.

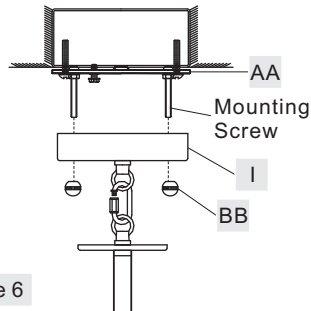

Figure 6

#### STEP 7 - Attach Crystal Pendants

- A. Attach Strings E (E) to the holes on the Loop Assembly (H) as shown.  
 B. Insert the String A (A) to the bottom center of the Socket Assembly (L). Insert the Strings B (B) to the holes on the locations B on the bottom center of the Socket Assembly (L). Insert the Strings C (C) to the hole on the locations A on the bottom center of the Socket Assembly (L). Insert the Strings D (D) to the hole on the locations D on the bottom center of the Socket Assembly (L).  
 C. Insert the Diffuser (M) inside of the Shade (N) and attach to the Tabs in the bottom edge of the Shade (N).

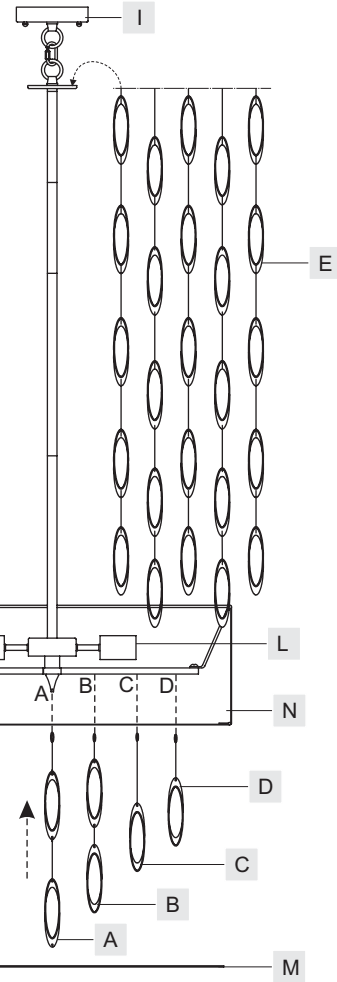
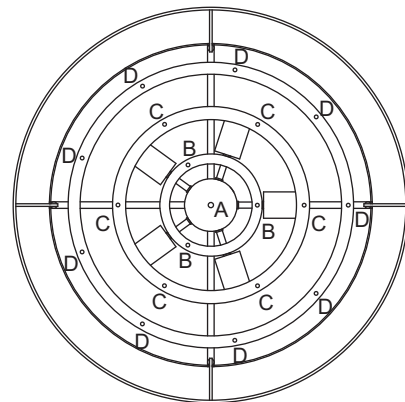

Figure 7

#### STRINGS DISTRIBUTION



#### STEP 8 - Install Bulb

- A. This fixture uses standard bulb with medium base. Maximum 60 watts.  
 B. Insert bulb and screw snugly into place.

Your fixture is now assembled and ready to use. Enjoy!

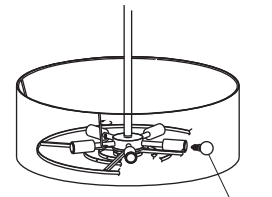
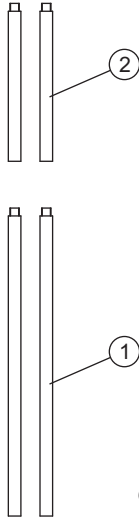
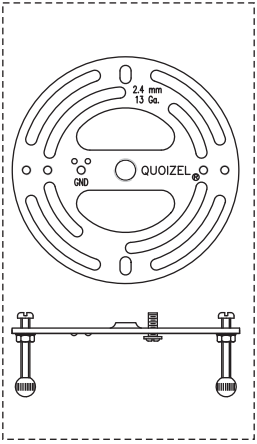

Figure 8

Thank you for purchasing a Quoizel product.  
 Need assistance with parts or assembly? Call Quoizel customer service at 1-631-273-2700  
 or visit us on-line at [www.quoise.com](http://www.quoise.com)

PCCS2824C | PCCS2824C1

FINISH: POLISHED CHROME



59"  
OVERALL HEIGHT  
INCLUDES  
(2) 6" AND (2) 12" RODS

NOTE: ONE LIGHT SHOWN FOR ILLUSTRATION PURPOSE ONLY.

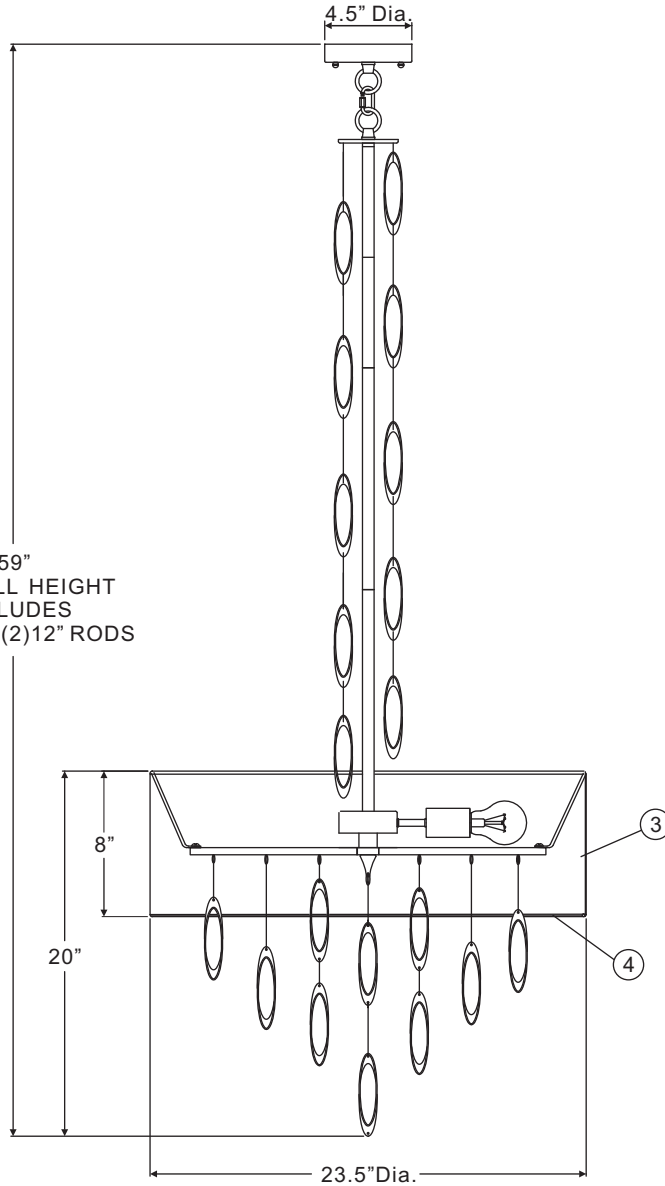

(5) 60W Medium Base Bulbs  
(Not Supplied)

NOTE: ALL DIMENSIONS ARE ROUNDED UP TO THE NEAREST 1/2"

NO.	PART NUMBER	REPLACEMENT PART DESCRIPTION	REQ.	ITEM NUMBER
1	9008EXC	ROD EXTENSION POLISHED CHROME 12"L X 0.63"D	2	PCCS2824C PCCS2824C1
2	9007EXC	ROD EXTENSION POLISHED CHROME 6"L X 0.63"D	2	
4	S1624DI	WHITE LINEN HARDBACK DIFFUSER 23.5"D	1	
3	S1611BK	SHADE BLACK W/SILVER INSIDE 24"D	1	PCCS2824C
3	S1612WH	SHADE WHITE W/ SILVER INSIDE 24"D	1	PCCS2824C1

Thank you for purchasing a Quoizel product.  
Need assistance with parts or assembly? Call Quoizel customer service at 1-631-273-2700  
or visit us on-line at [www.quoizel.com](http://www.quoizel.com)