

PACKAGE CONTENTS

ISSUED 03-2010

REVISED 2010-10-19

PART	DESCRIPTION	QUANTITY
A	Crossbar	1 pc
B	Green Ground Screw	1 pc
C	Hex Nut	3 pcs
D	Nipple	1 pc
E	Lock Washer	2 pcs
F	Canopy Chain Loop	1 pc
G	Canopy Lock Ring	1 pc
H	Fixture Chain	1 pc
I	Ceiling Canopy	1 pc
J	Socket Assembly	1 pc
K	Fixture Loop	1 pc
L	Center Column	1 pc
M	Side Chain	10 pcs
N	Crystal	30 pcs

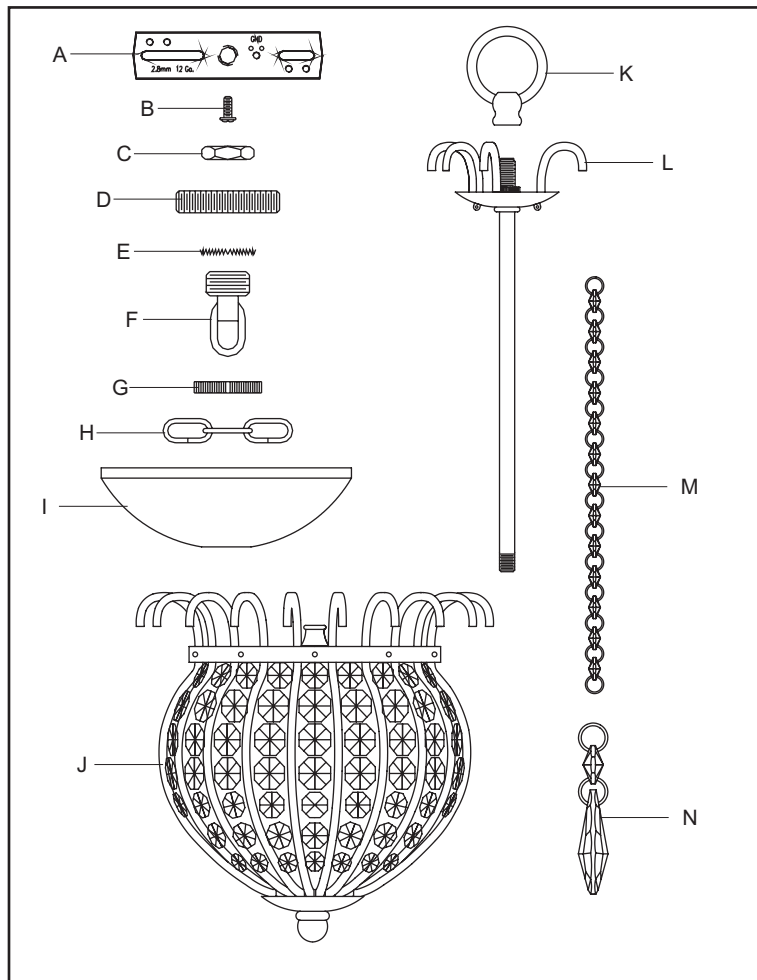

! WARNINGS AND CAUTIONS

WARNING:

- Before beginning the installation, turn off electricity at the circuit breaker box or the main fuse box by switching off the circuit breaker or removing the fuse.

CAUTION:

- These instructions are provided for your safety. It is very important that they are read completely before the installation of your fixture. We strongly recommend that a professional electrician install the fixture.
- Disconnect fixture from the power source before replacing the bulb(s), making sure that bulb(s) had sufficient time to cool down. DO NOT subject the lamp to any shock while lit as shattering of lamp may result.

PREPARATION

STYLE NUMBER: JLE2809IS

- Before beginning installation of product, make sure all parts are present. Compare parts with package contents list and diagram above. If any part is missing or damaged, do not attempt to assemble, install or operate the product. Contact customer service for replacement part.
- Estimated Assembly Time: 30 - 45 minutes
- Tool Required for Assembly (not included): Flathead screwdriver, Phillips screwdriver, Pliers, Electrical tape, Wire cutter, Safety glasses and (2) 60W B10 candelabra base bulbs.
- Helpful Tools (not included): Wire strippers.

INSTALLATION INSTRUCTIONS

STEP 1:

- a. Screw the end of the Center Column into the Coupling on the top center of the Socket Assembly. Please line up the Pin Holes at the side of the Fixture Canopy and the Pin Holes at the side of the Socket Assembly before tighten them together.

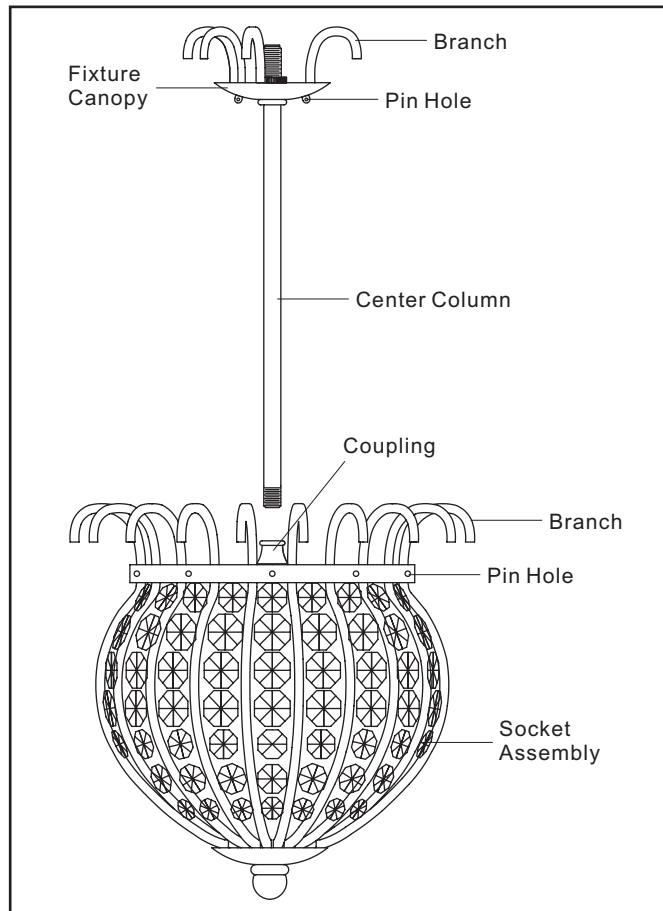

STEP 2:

- a. Thread the Fixture Loop onto the nipple on the top end of the Center Column. Hand-tighten until snug.

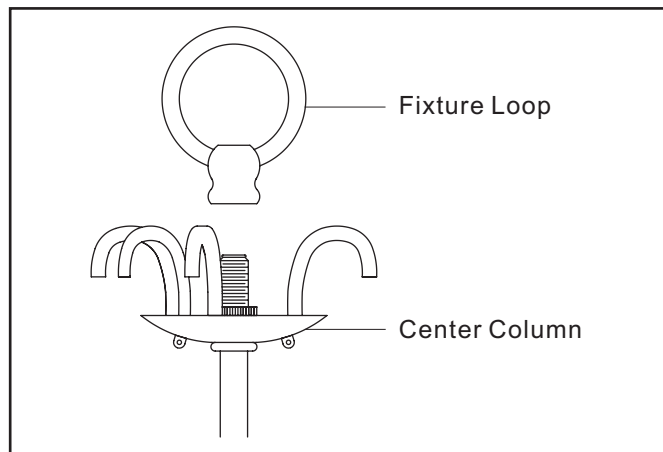

STEP 3:

- a. Secure the Crossbar onto the Outlet Box with Outlet Box Screws. Tighten until snug.

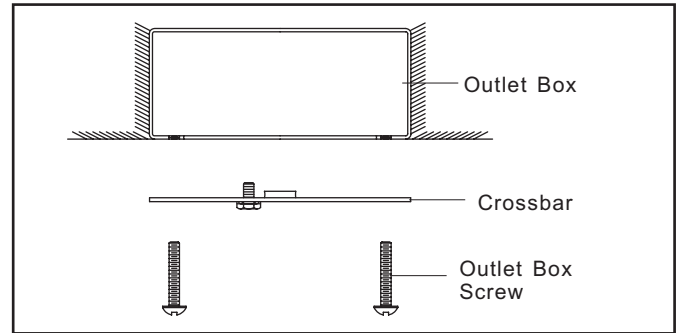

STEP 4:

- a. Thread one Hex Nut onto top end of the Nipple.
- b. Place one Lock Washer over the top end of the Nipple and then thread the Nipple into the center lock hole of the Crossbar.
- c. Using pliers, thread the Hex Nut against the Crossbar and hand-tighten until snug.

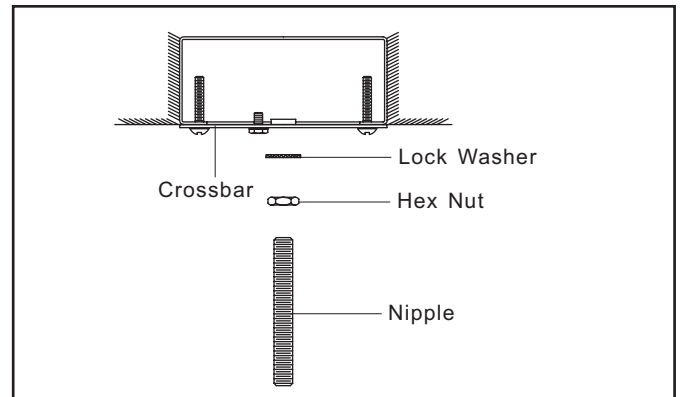

STEP 5:

- a. Thread another Hex Nut onto the end of the Nipple.
- b. Place the Lock Washer over the end of the Nipple and then thread the Canopy Chain Loop onto the end of the Nipple.
- c. Using pliers, thread the Hex Nut against the Canopy Chain Loop and hand-tighten until snug.

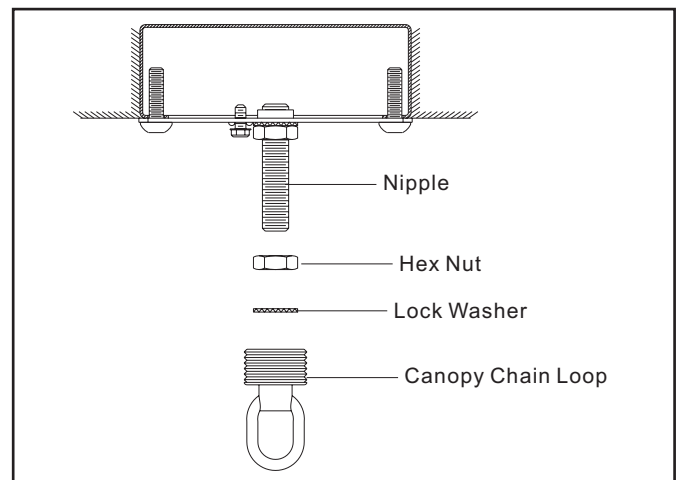

STEP 6:

- a. Push the Ceiling Canopy upward over the Outlet Box. Thread the Canopy Lock Ring onto the Canopy Chain Loop and tighten until snug to secure the Ceiling Canopy.

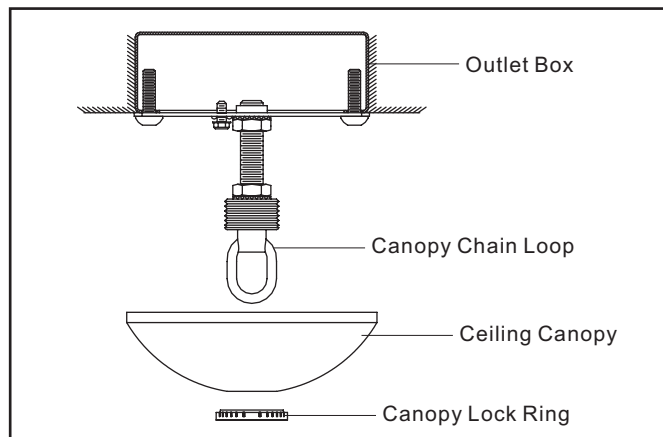

STEP 7:

- a. Adjust the Fixture Chain to your desired length by removing the links if needed. You may need to use pliers to open the chain links. If so, put a cloth over the chain to protect the finish from the pliers.
- b. Attach one end of the Fixture Chain onto the Canopy Chain Loop and then attach the other end of the Fixture Chain onto the Fixture Loop on the top of the fixture.

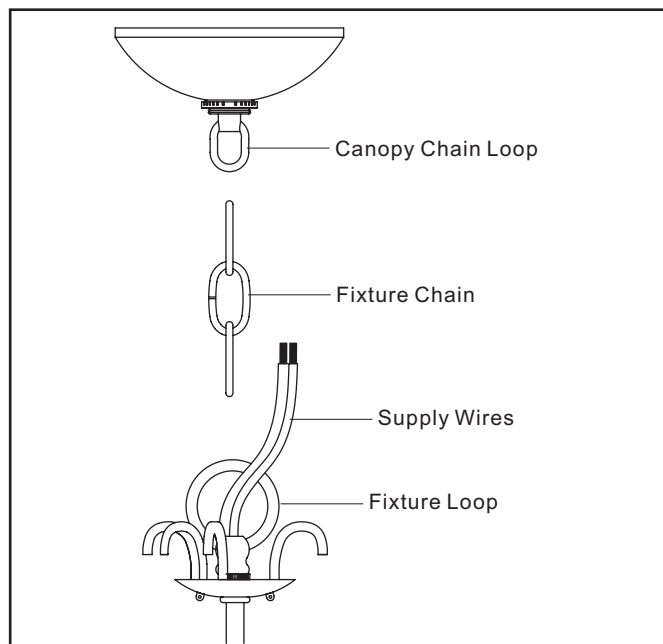

STEP 8:

- a. Pull the Supply Wires up through the Fixture Chain alternating links. Push the wires up through the Canopy Chain Loop into the outlet box.

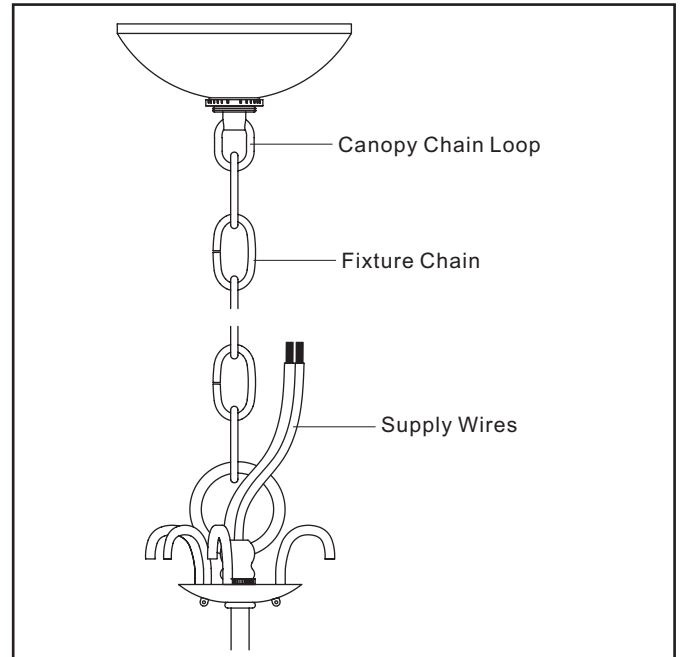

STEP 9:

- a. Un-thread the Canopy Lock Ring and slide Canopy Lock Ring and Ceiling Canopy down the Fixture Chain.
- b. Push all slack fixture wire through Canopy Chain Loop into Outlet Box. Trim excess fixture wire leaving a minimum of 6 in. Hanging out of the Outlet Box.
- c. Refer to STEP 10 to connect the wires.
- d. Re-attach the Ceiling Canopy as shown in STEP 6.

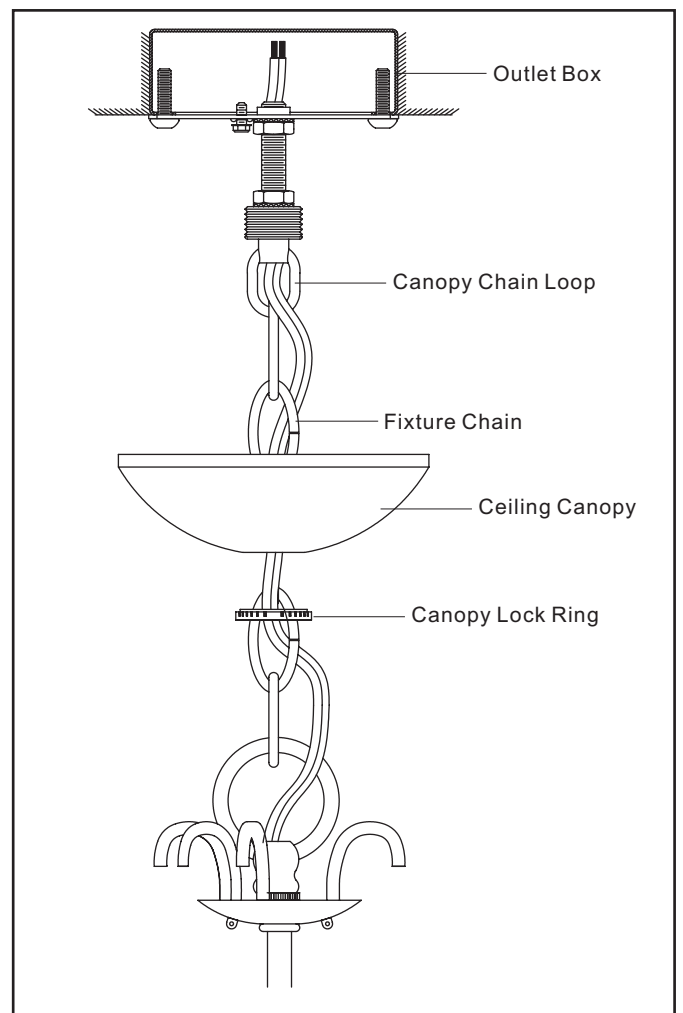

INSTALLATION INSTRUCTIONS

STYLE NUMBER: JLE2809IS

STEP 10:

- ★ Use Wire Connectors to connect the wires.
- a. Connect the House Ground Wire to the Fixture Ground Wire.
- b. Connect the House White (or Ribbed) Wire to the Fixture Supply Wire (Black or Smooth Side).
- c. Connect the House Black (or Red) Wire to the Fixture Supply Wire (Black or Smooth Side).
- d. Wrap each connection with approved electrical tape and carefully stuff all of the connected wires into the Outlet Box.

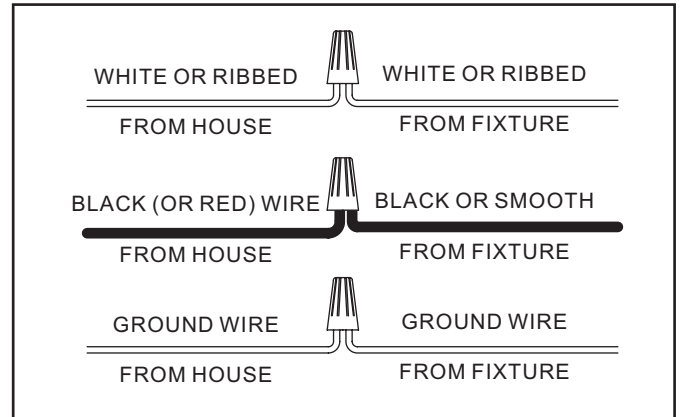

STEP 11:

- a. Install correct bulbs referring to fixture markings and/or labels for maximum wattage.

STEP 12:

- a. Attach one end of the Side Chain to the Pin Hole on the side of the Fixture Canopy. Attach the another end of the Side Chain to the Pin Hole on the side of the Cage.
- b. Attach Crystals to the Branches as shown.

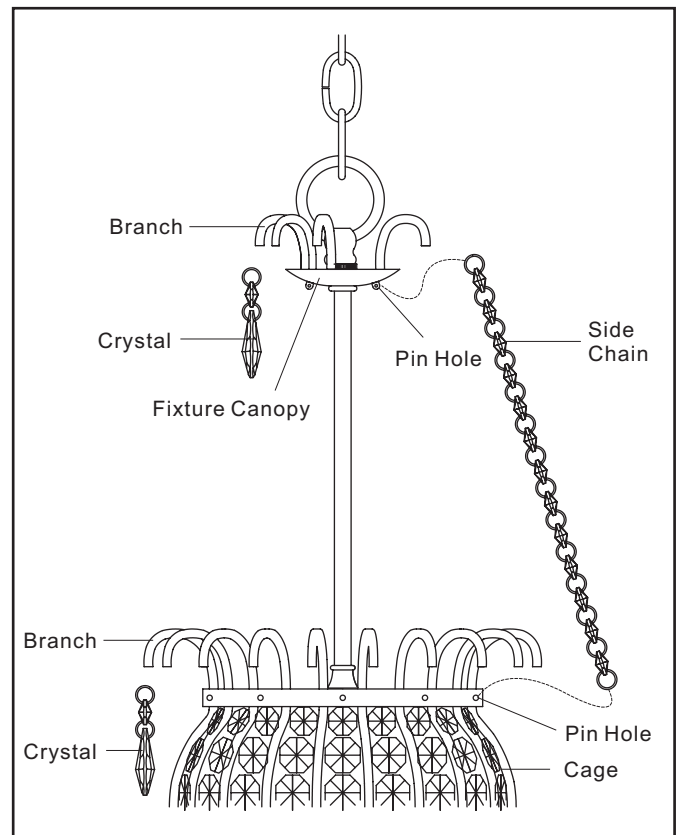

Your installation is completed now. Restore electricity. Retain this sheet for future reference.