

MIDDLEFIELD

FR40575IRR

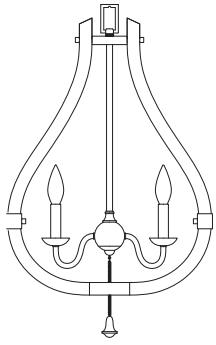

Bulbs: 3-60W CAND.

ASSEMBLY INSTRUCTIONS

Assembly of this fixture will be accomplished by first assembling the body of the fixture, installing the mounting hardware to the junction box, making all necessary electrical connections, hanging the fixture and then installing the fixture glass.

SAFETY WARNING: Read wiring and grounding instructions [FRIS 18] and any additional directions. Turn power supply off during installation. If new wiring is required, consult a qualified electrician or local authorities for code requirements.

STEP 1

- 1 First slip loop (1) along supply wire and thread onto stem (2) and tighten.
- See Drawing 1.
- 2 Fixture can now be installed, please return to this section to complete assembly after installation.

STEP 1 Refer to Hanging Instruction Sheet [FRIS19] to hang fixture. Then refer back to this sheet to continue installation of this fixture.

STEP 2

- 1 Slip candle sleeve (3) over socket (s) - See Drawing 1.
- 2 Hanger decorative wood penatlog (4) onto hook (h) locate at bottom of fixture.
NOTE: chain lenght on decorative pentalog can be adjusted to any length you prefer.

[DRAWING 1]

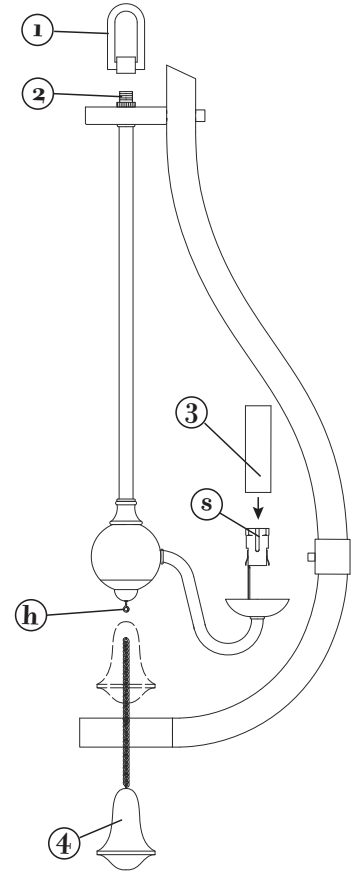

FREDRICK RAMOND
ESTABLISHED 1965

A Division of Hinkley Lighting, Inc.
33000 PIN OAK PARKWAY | AVON LAKE, OHIO 44012
toll free 800.446.5539 | phone 440.653.5500

FRIS19

HANGING INSTRUCTIONS

SAFETY WARNING: Read wiring and grounding instructions [FRIS 18] and any additional directions. Turn power supply off during installation. If new wiring is required, consult a qualified electrician or local authorities for code requirements.

STEP 1

- 1 Shut off electrical current before starting. If the fixture you are replacing is turned on and off by a wall switch, simply turn the switch off. If not, remove the appropriate fuse (or open the circuit breakers) until the fixture is dead.
 - DO NOT restore current - either by fuse, breaker or switch - until the new fixture is completely wired and in place.

STEP 2

- 1 Fasten mounting strap (1) to outlet box (a) with the original outlet box screws (2) - See Drawing 1.
- 2 Thread nipple (3) into mounting strap (1).
- 3 Thread loop (4) on to end of nipple (3).
- 4 Slip canopy (b) over loop (4) and adjust height of loop so half of thread area is exposed.

STEP 3

- 1 Taking the chain, determine the length you require to hang the fixture.
- 2 Attach one end of the chain to the top loop of the fixture - See Drawing 2.
- 3 Now slip loop collar (5) and canopy (b) onto chain.
- 4 Attach other end of chain to loop (4). Get assistance for this step since fixture may be heavy and difficult to hold while attaching the chain.

STEP 4

- 1 Unwrap supply wire and ground wire and weave them up through the chain.
- 2 Slip supply wire and ground wire through center of loop (4).
- 3 Connect ground wire to mounting strap (1) using green ground screw (6).
- 4 Make electrical connections from supply wire to fixture lead wires. Refer to instruction sheet [FRIS18] and follow all instructions to make all necessary wiring connections.
- 5 Slip canopy up firmly against the ceiling and secure by turning the threaded collar (5) on loop (4) until tight.

[DRAWING 1]

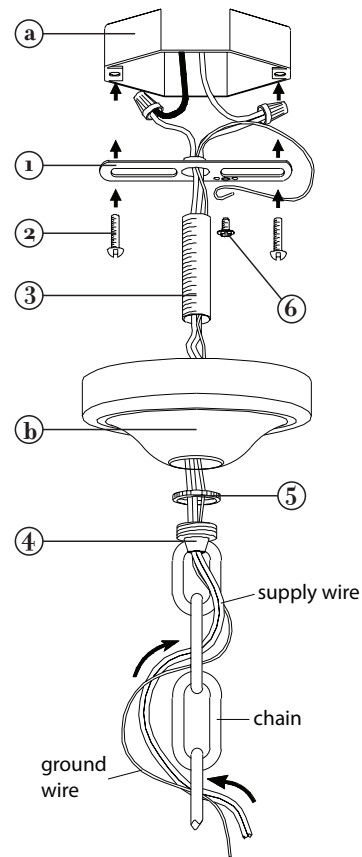

[DRAWING 2]

Half of thread area of loop (4) is to be exposed. This will allow collar (5) to be threaded on later.

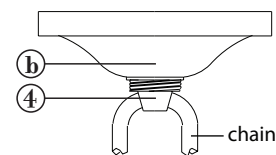

FREDRICK RAMOND
ESTABLISHED 1965

A Division of Hinkley Lighting, Inc.
33000 PIN OAK PARKWAY | AVON LAKE, OHIO 44012
toll free 800.446.5539 | phone 440.653.5500

WIRING AND GROUNDING INSTRUCTIONS

SAFETY WARNING: Read wiring and grounding instructions [FRIS 18] and any additional directions. Turn power supply off during installation. If new wiring is required, consult a qualified electrician or local authorities for code requirements.

STEP 1 WIRING INSTRUCTIONS

Indoor Fixtures

- 1 Connect positive supply wire (a) (typically black or the smooth, unmarked side of the two-conductor cord) to positive fixture lead (b) with appropriately sized twist on connector - See Drawings 1 or 2.
- 2 Connect negative supply wire (c) (typically white or the ribbed, marked side of the two-conductor cord) to negative fixture lead (d).
- 3 Please refer to the grounding instructions below to complete all electrical connections.

Outdoor Fixtures

- 1 Connect positive supply wire (a) (typically black or the smooth unmarked side of the two-conductor cord) to positive fixture lead (b) with appropriately sized twist on connector - See Drawings 2 or 3.
- 2 Connect negative supply wire (c) (typically white or the ribbed, marked side of the two-conductor cord) to negative fixture lead (d).
- 3 Cover open end of connectors with silicone sealant to form a watertight seal.
 - If installing a wall mount fixture, use caulk to seal gaps between the fixture mounting plate (backplate) and the wall. This will help prevent water from entering the outlet box. If the wall surface is lap siding, use caulk and a fixture mounting platform specially.
- 4 Please refer to the grounding instructions below to complete all electrical connections.

STEP 2 GROUNDING INSTRUCTIONS

Flush Mount Fixtures

For positive grounding in a 3-wire electrical system, fasten the fixture ground wire (e) (typically copper or green plastic coated) to the fixture mounting strap (1) with the ground screw (2) - See Drawing 1.

Note: On straps for screw supported fixtures, first install the two mounting screws in strap.

Any remaining tapped hole may be used for the ground screw.

Chain Hung Fixtures

Loop fixture ground wire (e) (typically copper or green plastic coated) under the head of the ground screw (2) on fixture mounting strap (1) and connect to the loose end of the fixture ground wire directly to the ground wire of the building system with appropriately sized twist-on connectors - See Drawing 2.

Post-Mount Fixtures

Connect fixture ground wire (e) (typically copper or green plastic coated) to power supply ground with appropriately sized twist-on connector inside post. Cover open end of connector with silicone sealant to form a watertight seal - See Drawing 3.

[drawing 1]

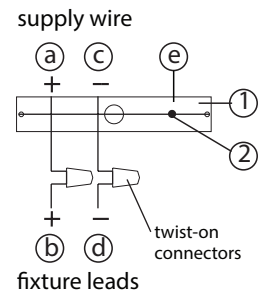

[drawing 2]

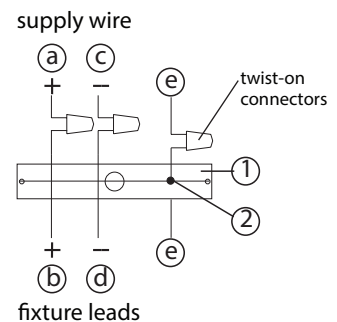

[drawing 3]

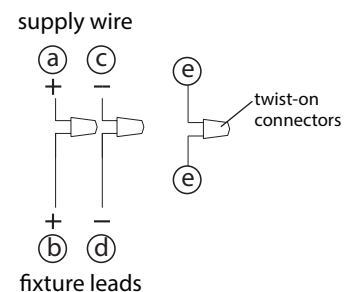

FREDRICK RAMOND
ESTABLISHED 1965

A Division of Hinkley Lighting, Inc.
33000 PIN OAK PARKWAY | AVON LAKE, OHIO 44012
toll free 800.446.5539 | phone 440.653.5500