

SAN SIMEON

FR59194SLF



Bulbs: 100W MED.

Replacement Parts: GLASS: FR49190GL

ASSEMBLY INSTRUCTIONS

Assembly of this fixture will be accomplished by first installing the mounting strap to the junction box, making all necessary electrical connections, mounting the fixture to the wall and then installing the fixture glass.

SAFETY WARNING: Read wiring and grounding instructions [FRIS 18] and any additional directions. Turn power supply off during installation. If new wiring is required, consult a qualified electrician or local authorities for code requirements.

STEP 1

- 1 Prepare mounting strap (a) by threading the two longest mounting screws (b) into the back of the mounting strap (a), making sure the holes into which the screws are threaded match the spacing of holes (d) in the backplate (e) - See Drawing 1.
- 2 Attach mounting strap (a) to junction box (j) using two screws (c) not provided.
- 3 Make electrical connections from supply wire to fixture lead wires. Refer to instruction sheet [FRIS18] and follow all instructions to make all necessary wiring connections. Then refer back to this sheet to continue installation of this fixture.
- 4 To mount fixture, slip the two mounting screws (b) through the two mounting holes (d) in the backplate (e).
- 5 While holding fixture in place, thread the two ball knobs (f) on to the end of the mounting screws (b), and tighten.

STEP 2

- 1 Slip glass (2) over socket (1) - See Drawing 2.
- 2 Thread socket ring (3) over socket (1) to secure glass.
- 3 Fixture can now be lamped accordingly.

[DRAWING 1]

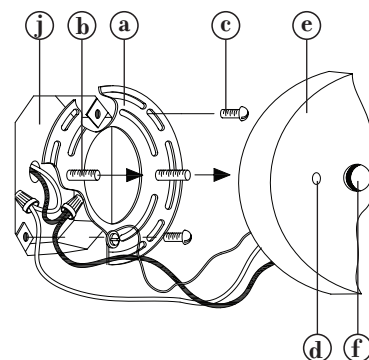

[DRAWING 2]

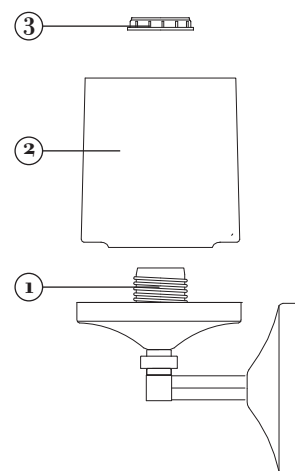

FREDRICK RAMOND
ESTABLISHED 1965

A Division of Hinkley Lighting, Inc.
33000 PIN OAK PARKWAY | AVON LAKE, OHIO 44012
toll free 800.446.5539 | phone 440.653.5500

WIRING AND GROUNDING INSTRUCTIONS

SAFETY WARNING: Read wiring and grounding instructions [FRIS 18] and any additional directions. Turn power supply off during installation. If new wiring is required, consult a qualified electrician or local authorities for code requirements.

STEP 1 WIRING INSTRUCTIONS

Indoor Fixtures

- 1 Connect positive supply wire (a) (typically black or the smooth, unmarked side of the two-conductor cord) to positive fixture lead (b) with appropriately sized twist on connector - See Drawings 1 or 2.
- 2 Connect negative supply wire (c) (typically white or the ribbed, marked side of the two-conductor cord) to negative fixture lead (d).
- 3 Please refer to the grounding instructions below to complete all electrical connections.

Outdoor Fixtures

- 1 Connect positive supply wire (a) (typically black or the smooth unmarked side of the two-conductor cord) to positive fixture lead (b) with appropriately sized twist on connector - See Drawings 2 or 3.
- 2 Connect negative supply wire (c) (typically white or the ribbed, marked side of the two-conductor cord) to negative fixture lead (d).
- 3 Cover open end of connectors with silicone sealant to form a watertight seal.
 - If installing a wall mount fixture, use caulk to seal gaps between the fixture mounting plate (backplate) and the wall. This will help prevent water from entering the outlet box. If the wall surface is lap siding, use caulk and a fixture mounting platform specially.
- 4 Please refer to the grounding instructions below to complete all electrical connections.

STEP 2 GROUNDING INSTRUCTIONS

Flush Mount Fixtures

For positive grounding in a 3-wire electrical system, fasten the fixture ground wire (e) (typically copper or green plastic coated) to the fixture mounting strap (1) with the ground screw (2) - See Drawing 1.

Note: On straps for screw supported fixtures, first install the two mounting screws in strap.

Any remaining tapped hole may be used for the ground screw.

Chain Hung Fixtures

Loop fixture ground wire (e) (typically copper or green plastic coated) under the head of the ground screw (2) on fixture mounting strap (1) and connect to the loose end of the fixture ground wire directly to the ground wire of the building system with appropriately sized twist-on connectors - See Drawing 2.

Post-Mount Fixtures

Connect fixture ground wire (e) (typically copper or green plastic coated) to power supply ground with appropriately sized twist-on connector inside post. Cover open end of connector with silicone sealant to form a watertight seal - See Drawing 3.

[drawing 1]

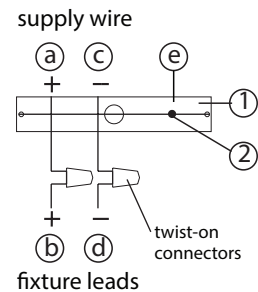

[drawing 2]

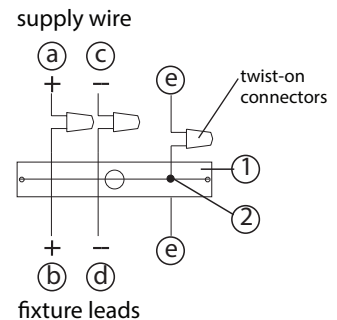

[drawing 3]

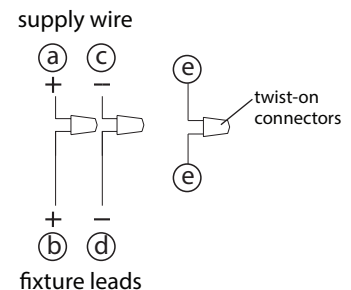

FREDRICK RAMOND
ESTABLISHED 1965

A Division of Hinkley Lighting, Inc.
33000 PIN OAK PARKWAY | AVON LAKE, OHIO 44012
toll free 800.446.5539 | phone 440.653.5500