

CRYST RAMA



1958

95 Cantiague Rock Road, Westbury NY 11590

ph:516.931.9090 fax: 516. 931.1254

info@crystorama.com www.crystorama.com

MODEL#:133

ASSEMBLY AND DRESSING INSTRUCTIONS



All electrical components must be installed by a licensed electrician in accordance with the National Electric Code and the appropriate local electrical codes.



Top View

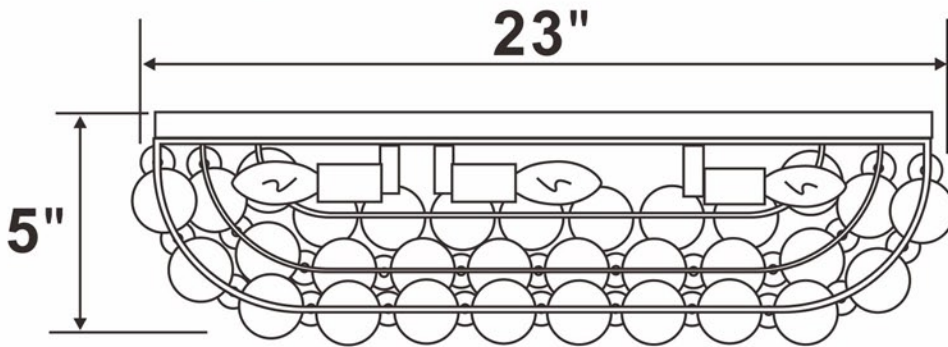

Side View

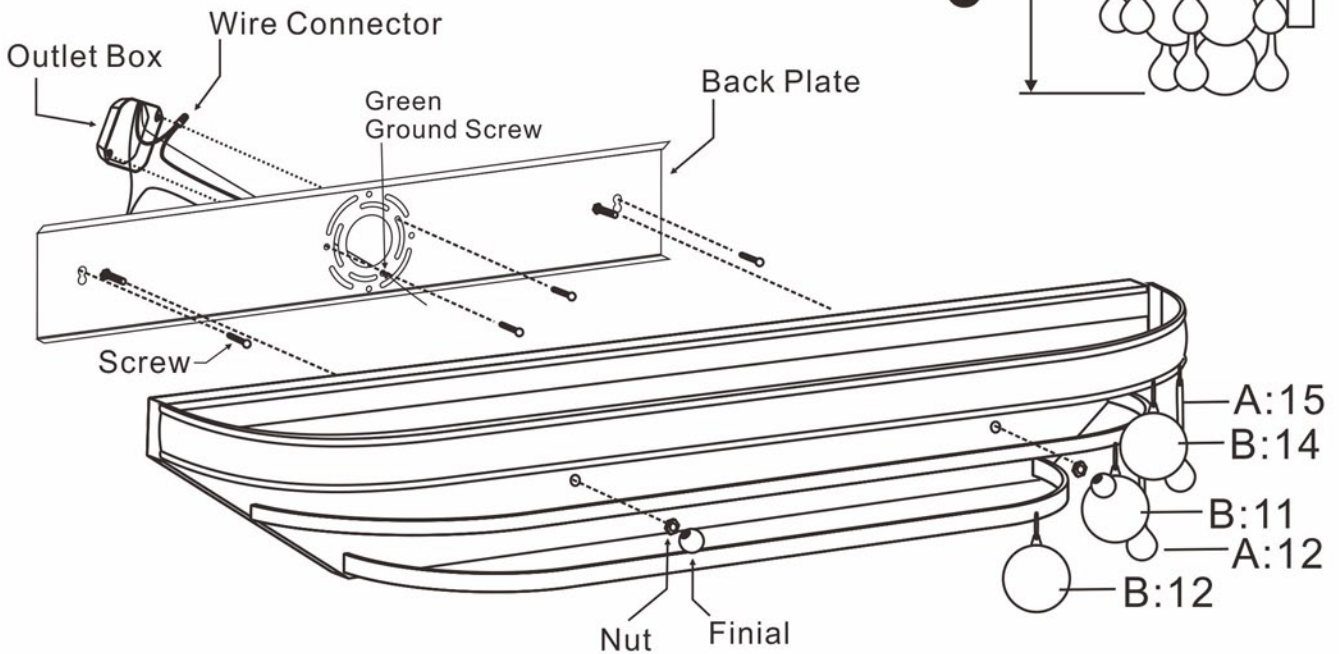
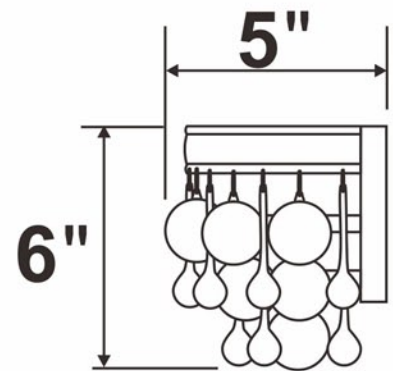

A= 76mm * 27sets

B= 40mm * 37sets

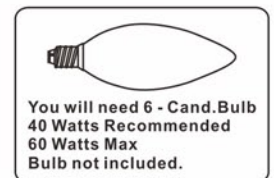

PREPARATORY WORK

Before installing this item,
please complete the preparatory work as following:

1. Drill two holes on the wall to match the side holes of the backplate.

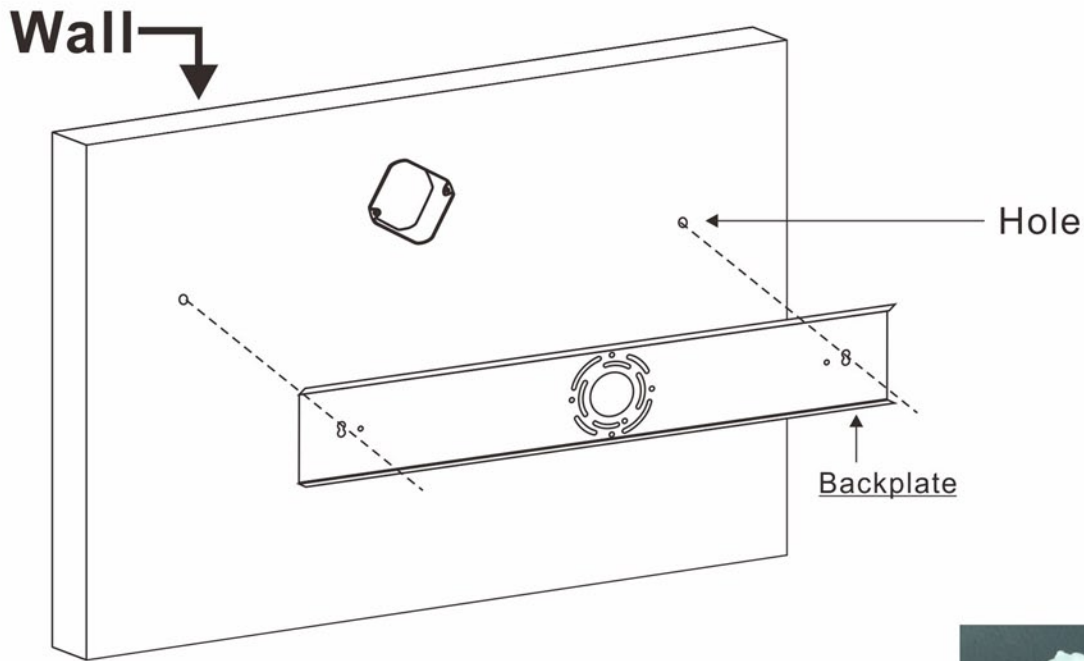

2. Insert the plastic wall plug into the holes on the wall.

