

Tools Required: Flathead screwdriver, Phillips screwdriver, pliers, wire cutters, wire strippers, electrical tape, safety glasses.

Bulb Recommended: LED 20W

Estimated Assembly Time: 20-30 minutes

Preparation: Identify and inspect all parts before beginning installation. Check package content list and diagrams below to be sure all parts are present. If any parts are missing or damaged, do not attempt to assemble, install, or operate the fixture. Contact customer service for replacement parts.

⚠ Warnings and Cautions

Turn off electricity at circuit breaker or main fuse box before installation. Consult a licensed electrician if in doubt.

These instructions are provided for your safety. It is very important you read them completely before installing the fixture. We strongly recommend that a licensed, professional electrician perform the installation.

Disconnect fixture from power source before replacing bulbs. Make sure bulbs are given sufficient time to cool before removal. Do not subject glass parts to any shock while in operation or shattering may result.

Do not touch the bulb with bare hands use a cloth or glove.

Package Contents

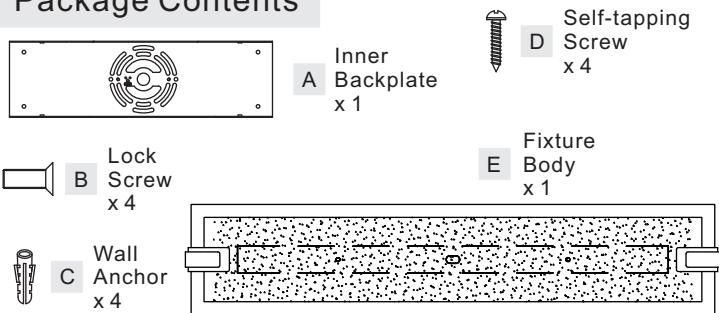

STEP 1 - Attach Inner Backplate and Fixture Body

- Remove the Package Material from the both side of Fixture Body (E).
- Place the Inner Backplate (A) onto the Wall surface and line up one set of holes onto mounting holes on Outlet Box. Using a pencil, mark the locations for Wall Anchors (C).
- Remove the Inner Backplate (A) and drill holes from the marks on the wall surface and then push the Wall Anchors (C) into the holes.
- Pass the supply wires through Inner Backplate (A). Position the Inner Backplate (A) back onto the Wall, secure by threading the Outlet Box Screws (not supplied) into the mounting holes on the Outlet Box and screw Self-tapping Screws (D) into the Wall Anchors (C). Tighten until snug.
- Race all supply wires through the Inner Backplate (A) as shown. Refer to Step 3 for wiring connections.
- Attach fixture over Inner Backplate (A) and secure with Lock Screws (B). Tighten until snug with screwdrivers.

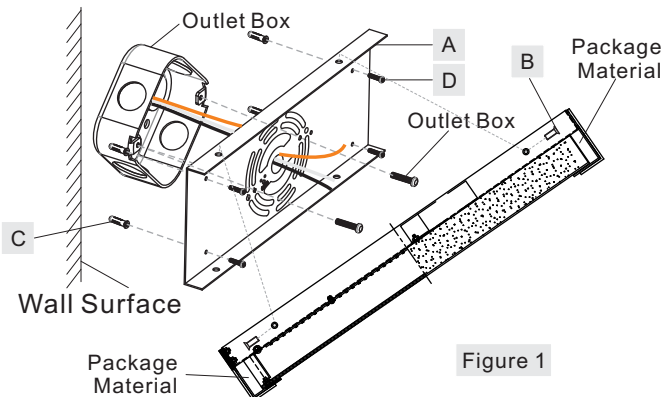

Figure 1

STEP 2 - Wire Connections

- Use standard wire connectors (not included) to make all wire connections. (Connectors are not included with fixture.) Twist connectors until wires are tightly joined together. Wrap each connection with approved electrical tape and carefully stuff all the connected wires between Inner Backplate (A) and Fixture Body (L).

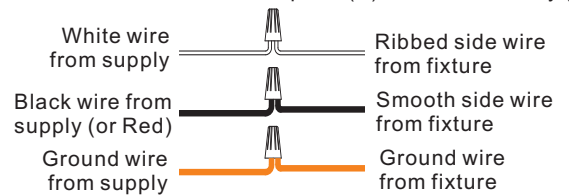

Figure 2

STEP 3 - Replace Shade

- Remove Fixture Body from Wall Surface by unlocking Lock Screws.
- Unscrew Hex Nut in the backplate. Remove Outer Shade Holders and Shade with Inner Shade Holders from Backplate.
- Unscrew Hex Nuts in the Shade and remove Inner Shade Holders.
- Reverse above steps to reinstall the replacement Shade onto fixture.

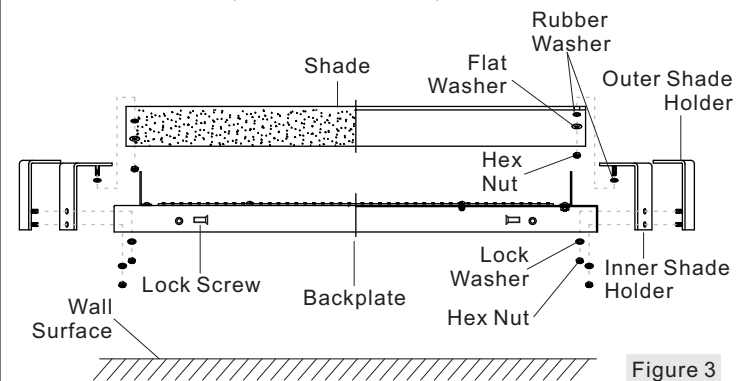
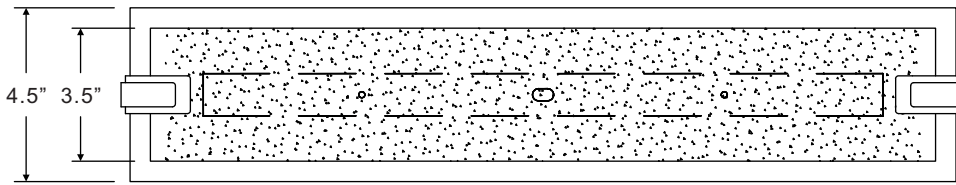
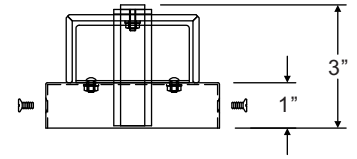
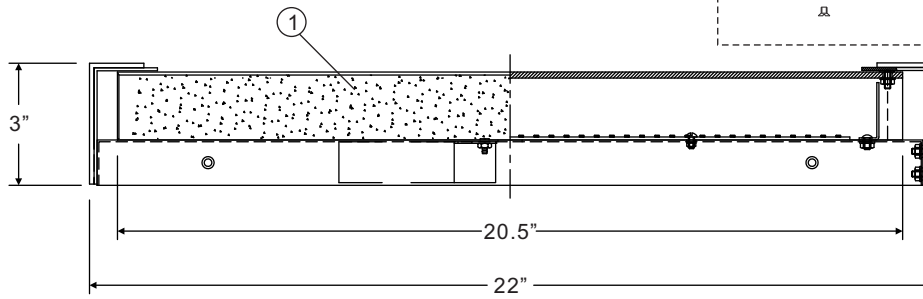
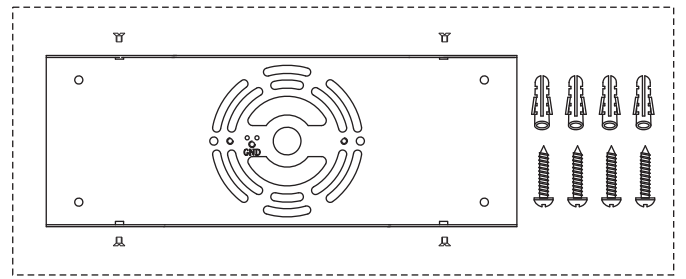

Figure 3

Thank you for purchasing a Quoizel product.
Need assistance with parts or assembly? Call Quoizel customer service at 1-631-273-2700
or visit us on-line at www. quozel. com

PCDH8522BN

FINISH: BRUSHED NICKEL



NOTE: ALL DIMENSIONS ARE ROUNDED UP TO THE NEAREST 1/2"

NO.	PART NUMBER	REPLACEMENT PART DESCRIPTION	REQ.
1	G3672SH	SHADE	1

Thank you for purchasing a Quozel product.
Need assistance with parts or assembly? Call Quozel customer service at 1-631-273-2700
or visit us on-line at www.quozel.com