

PACKAGE CONTENTS

ISSUED 09-2009

Revised 2013-08-23

Part	Description	Quantity
A	Crossbar	1pc
B	Green Ground Screw	1pc
C	Nipple	1pc
D	Lock Washer	1pc
E	Hex Nut	1pc
F	Lock Ball	1pc
G	Socket Collar	2pcs
H	Steel Collar	2pcs
I	Bulb Shield	2pcs
J	Shade	2pcs
K	Bulb	2pcs
L	Fixture Body	1pc

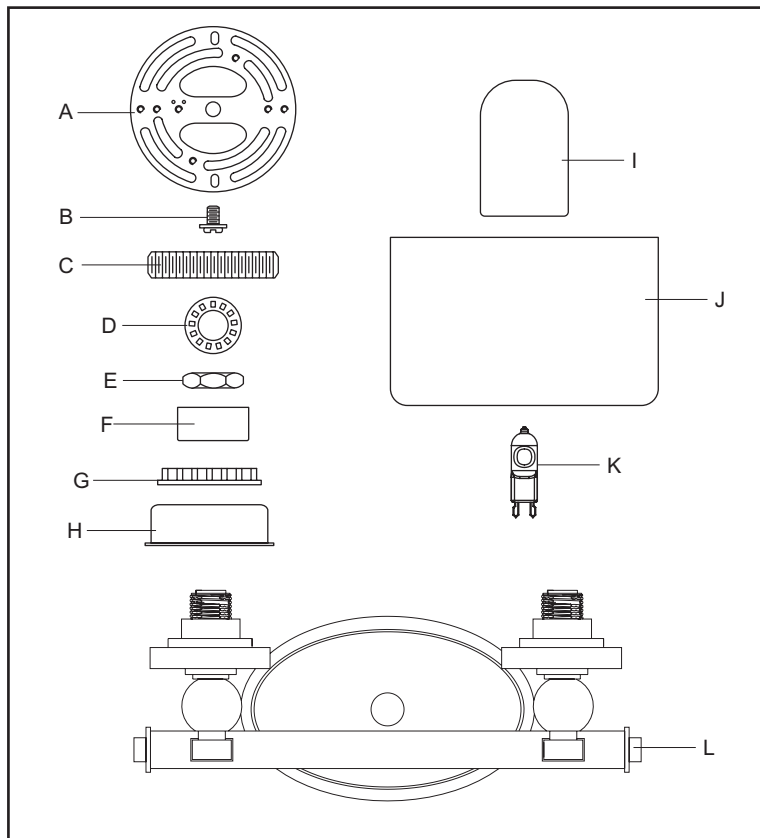

! WARNINGS AND CAUTIONS

WARNING:

- Before beginning the installation, turn off electricity at the circuit breaker box or the main fuse box by switching off the circuit breaker or removing the fuse.

CAUTION:

- These instructions are provided for your safety. It is very important that they are read completely before the installation of your fixture. We strongly recommend that a professional electrician install the fixture.
- Disconnect fixture from the power source before replacing the bulb(s), making sure the bulb(s) had sufficient time to cool down. DO NOT subject the lamp to any shock while lit as shattering of lamp may result.
- Do not touch the bulb with bare hands use a cloth or glove.

PREPARATION

- Before beginning installation of product, make sure all parts are present. Compare parts with package contents list and diagram above. If any part is missing or damaged, do not attempt to assemble, install or operate the product. Contact customer service for replacement part.
- Estimated Assembly Time : 20 - 30 minutes
- Tools Required for Assembly (not included) : Flathead Screwdriver, Phillips Screwdriver, Pliers, Electrical Tape, Wire Cutters, Safety Glasses & 2, 60 Watt, Frosted JCD G9 Bulbs.
- Helpful Tools (not included) : Wire Strippers.

STEP 1:

- a. Secure the Crossbar to the Outlet Box with Outlet Box Screws. Tighten until snug.

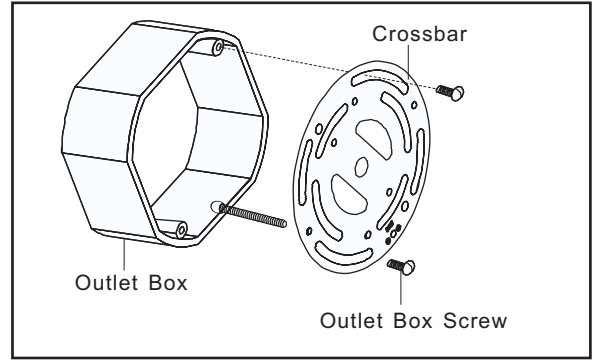

STEP 2:

* Pliers is required on this step.

- a. Thread the Hex Nut onto one end of the Nipple.
- b. Place the Lock Washer over the hex nut end of the Nipple and then thread the Nipple into the center lock hole of the Crossbar.
- c. Using pliers, thread the Hex Nut against the Crossbar and hand tighten until snug.

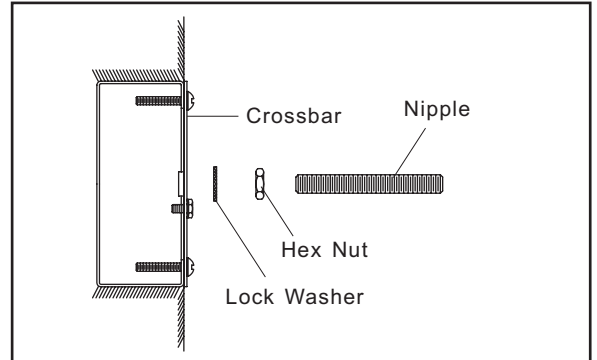

STEP 3:

*Use Wire Connectors (not supplied) to connect the wires.

- a. Connect the House Ground Wire to the Fixture Ground Wire.
- b. Connect the House White (or Ribbed) Wire to the Fixture Supply Wire (White or Ribbed Side).
- c. Connect the House Black (or Red) Wire to the Fixture Supply Wire (Black or Smooth Side).
- d. Wrap each connection with approved electrical tape and carefully stuff all of the connected wires into the Outlet Box.

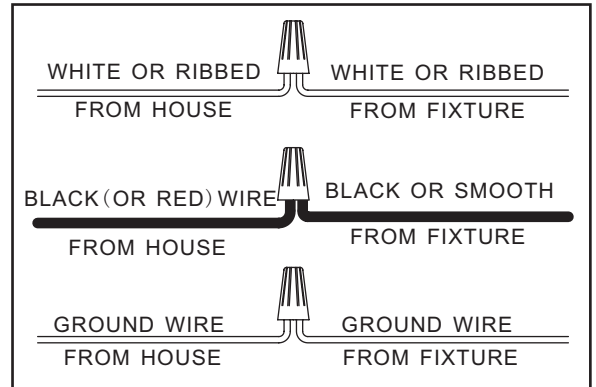

STEP 4:

- a. Place the Backplate over the Outlet Box as shown. Secure by threading the Lock Ball onto the Nipple. Hand tighten until snug.

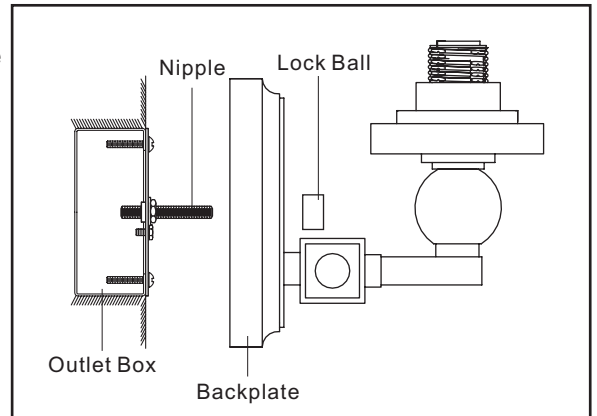

STEP 5 :

- a. Place the Shade and the Steel Collar over the Socket as shown. Secure by threading the Socket Collar onto the Socket. Hand tighten until snug.
- b. Install the correct Bulb referring to fixture markings and /or labels for maximum wattage.
IMPORTANT: Do not touch the bulb with bare hands use a cloth or glove.
- c. Thread the Bulb Shield onto the Socket. Hand tighten until snug.

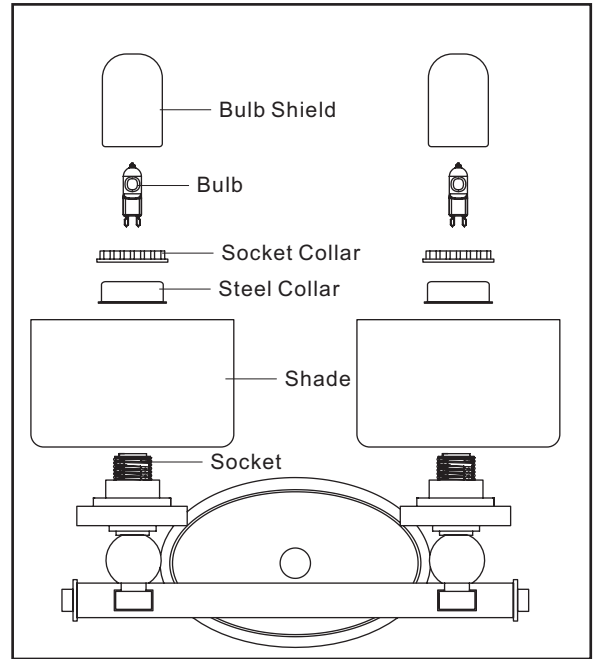

Your installation is completed now. Restore electricity. Retain this sheet for future reference.