

Family: Yorktown | Item No. 3628

## ▼ start here

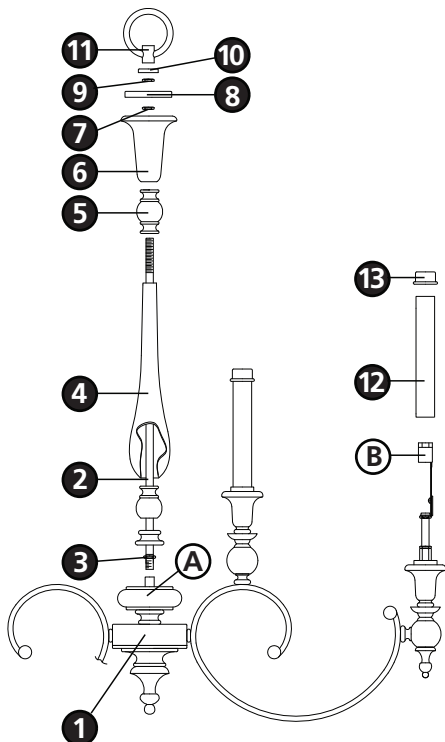

**Drawing 1 - Fixture Assembly**



**Drawing 2 - Fixture Assembly**

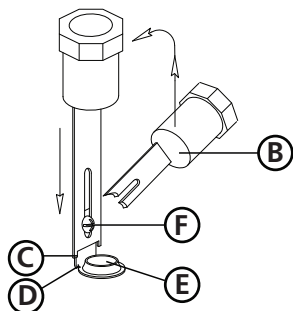

**1**

1. Find a clear area in which you can work.
2. Unpack fixture and glass from carton.
3. Carefully review instructions prior to assembly.

**\*\*\* The construction of this fixture will be accomplished by first assembling the main body of the fixture, making all necessary electrical connections, and then hanging the fixture from the ceiling.**

**SAFETY WARNING: READ WIRING AND GROUNDING INSTRUCTIONS (I.S. 18) AND ANY ADDITIONAL DIRECTIONS. TURN POWER SUPPLY OFF DURING INSTALLATION. IF NEW WIRING IS REQUIRED, CONSULT A QUALIFIED ELECTRICIAN OR LOCAL AUTHORITIES FOR CODE REQUIREMENTS.**

**2**

**NOTE:** All the parts for the center column assembly are laced on the supply wire. During assembly parts will be slipped along the wire. Caution should be used during this process.

1. to assemble the center column, take the steel center stem (2) and thread it into coupler (A) located on the main body assembly (1), approximately 1/2". Then tighten hex nut (3) against coupler to lock center stem in place - see **Drawing 1**.
2. Slip column (4) along wire and over center stem (2), followed by the top casting (5) and cup (6).
3. Thread hex nut (7) down on the center stem (2) approximately 1". It will need to be adjusted in the next step.
4. Now slip cap (8) onto center stem (2). The outer edge should fit and rest inside cup (6). Hex nut (7) should be adjusted so it just touches the underside of cap (8).
5. Thread hex nut (9) onto center stem (2) and tighten to secure center column assembly.
6. Slip cap (10) onto center stem (2) to cover hex nut (9).
7. To complete center column assembly slip loop (11) along wire and thread onto top of center tube (2) and tighten.
8. Please refer to the hanging instruction sheet (I.S. 19) provided to hang this fixture. Then refer back to this sheet to install the glass.

**3**

1. To prepare the sockets to accept the candle sleeves, it will be necessary to lock them in position. To accomplish this, first tilt bulb socket and bracket (B) up in a vertical position- see **Drawing 2**.
2. Slip the socket and bracket (B) down until the two tabs (C) engage the notch (D) that is in the base socket bracket (E).
3. Tighten screw (F) to lock sockets in position. Repeat for remaining sockets.
4. Slip candle sleeves (12) over sockets (B) followed by candle chaser (13) and repeat for remaining sockets - see **Drawing 1**.

**Drawing 1 - Hanging Assembly**

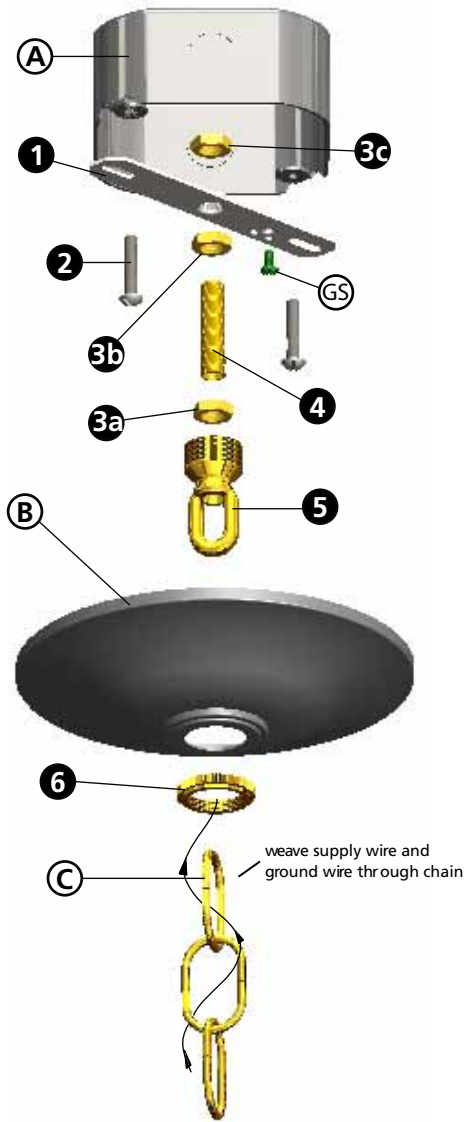

**Drawing 2 Canopy Adjustment**



## ▼ start here

**SAFETY WARNING: READ WIRING AND GROUNDING INSTRUCTIONS (I.S. 18) AND ANY ADDITIONAL DIRECTIONS. TURN POWER SUPPLY OFF DURING INSTALLATION. IF NEW WIRING IS REQUIRED, CONSULT A QUALIFIED ELECTRICIAN OR LOCAL AUTHORITIES FOR CODE REQUIREMENTS.**

### 1

1. Shut off electrical current before starting. If the fixture you are replacing is turned on and off by a wall switch, simply turn the switch off. If not, remove the appropriate fuse (or open the circuit breakers) until the fixture is dead.
  - DO NOT restore current - either by fuse, breaker or switch - until the new fixture is completely wired and in place.

### 2

1. fasten mounting strap (1) to outlet box (A) with the two 8-32 screws (2) -see Drawing 1.
2. Thread 2 - hex nuts (3a) and (3b) onto threaded tubing (4).
3. Thread one end of threaded tubing (4) into loop (5) a minimum of 1/2" to 3/4". Tighten hexnut (3a) against loop (5) to lock loop in position.
4. Thread other end of threaded tube (4) into mounting strap (1) approximately 1/2".
5. Slip canopy (B) over loop (5) and adjust height of loop so half of the threaded area on the loop is exposed - see Drawing 2 below. After loop height is adjusted, tighten hex nut (3b) up against mounting strap, tighten against mounting strap to lock loop and threaded tube in position.
6. Remove mounting strap (1) from junction box (A), and thread third hex nut (3c) onto end of threaded tube (4) above the mounting strap, tighten against mounting strap to lock assembly in position.
7. Remount mounting strap to junction box.

### 3

1. Taking the chain, determine the length you require to hang the fixture.
2. Attach one end of the chain to the top loop of the fixture - see **Drawing 2**.
3. Now slip loop collar (5) and canopy (B) onto chain.
4. Attach other end of chain to loop (4). Get assistance for this step since fixture may be heavy and difficult to hold while attaching the chain.

### 4

1. Unwrap supply wire and ground wire and weave them up through the chain.
2. Slip supply wire and ground wire through center of loop (4).
3. Connect ground wire to mounting strap (1) using green ground screw (6).
4. Make electrical connections from supply wire to fixture lead wires. Refer to instruction sheet (I.S. 18) and follow all instructions to make all necessary wiring connections.
5. Slip canopy up firmly against the ceiling and secure by turning the threaded collar (5) on loop (4) until tight.

## Drawing 1 - Flush Mount



## Drawing 2 - Chain Hung



## Drawing 3 - Post-Mount



**SAFETY WARNING: READ WIRING AND GROUNDING INSTRUCTIONS (I.S. 18) AND ANY ADDITIONAL DIRECTIONS. TURN POWER SUPPLY OFF DURING INSTALLATION. IF NEW WIRING IS REQUIRED, CONSULT A QUALIFIED ELECTRICIAN OR LOCAL AUTHORITIES FOR CODE REQUIREMENTS.**

## wiring instructions

### Indoor Fixtures

1. Connect positive supply wire **(A)** (typically black or the smooth, unmarked side of the two-conductor cord) to positive fixture lead **(B)** with appropriately sized twist on connector - see **Drawings 1 or 2**.
2. Connect negative supply wire **(C)** (typically white or the ribbed, marked side of the two-conductor cord) to negative fixture lead **(D)**.
3. Please refer to the **grounding instructions** below to complete all electrical connections.

### Outdoor Fixtures

1. Connect positive supply wire **(A)** (typically black or the smooth unmarked side of the two-conductor cord) to positive fixture lead **(B)** with appropriately sized twist on connector - see **Drawings 2 or 3**.
2. Connect negative supply wire **(C)** (typically white or the ribbed, marked side of the two-conductor cord) to negative fixture lead **(D)**.
3. Cover open end of connectors with silicone sealant to form a watertight seal.
  - If installing a wall mount fixture, use caulk to seal gaps between the fixture mounting plate (backplate) and the wall. This will help prevent water from entering the outlet box. If the wall surface is lap siding, use caulk and a fixture mounting platform specially.
4. Please refer to the **grounding instructions** below to complete all electrical connections.

## grounding instructions

### Flush Mount Fixtures

For positive grounding in a 3-wire electrical system, fasten the fixture ground wire **(E)** (typically copper or green plastic coated) to the fixture mounting strap **(1)** with the ground screw **(2)** - see **Drawing 1**.

Note: On straps for screw supported fixtures, first install the two mounting screws in strap. Any remaining tapped hole may be used for the ground screw.

### Chain Hung Fixtures

Loop fixture ground wire **(E)** (typically copper or green plastic coated) under the head of the ground screw **(2)** on fixture mounting strap **(1)** and connect to the loose end of the fixture ground wire directly to the ground wire of the building system with appropriately sized twist-on connectors - see **Drawing 2**.

### Post-Mount Fixtures

Connect fixture ground wire **(E)** (typically copper or green plastic coated) to power supply ground with appropriately sized twist-on connector inside post. Cover open end of connector with silicone sealant to form a watertight seal - see **Drawing 3**.