

Drawing 1 - Fixture Mounting

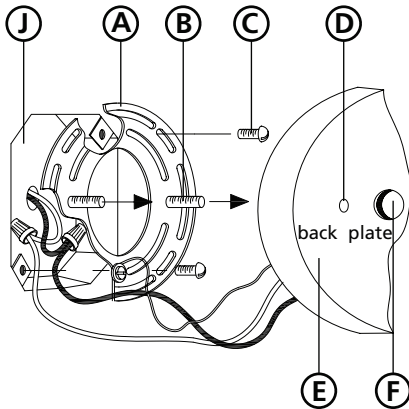

Drawing 2 - Glass Installation

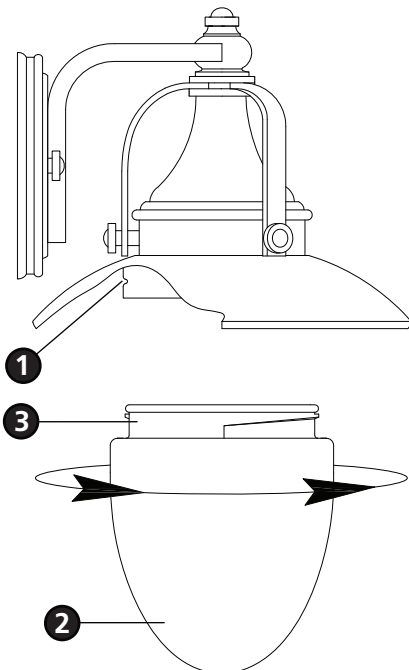

▼ start here

1

1. Find a clear area in which you can work.
2. Unpack fixture and glass from carton.
3. Carefully review instructions prior to assembly.

***** The construction of this fixture will be accomplished by first attaching the mounting strap to the junction box, making all necessary electrical connections, mounting the fixture to the wall and then installing the glass.**

2

1. Prepare mounting strap (A) by threading the two 1 1/4" long mounting screws (B) into the back of the mounting strap (A) - see **Drawing 1**.
 - Be sure the holes into which the screws are threaded match the spacing of holes (D) in the backplate (E).
2. Attach mounting strap (A) to junction box (J) using two 1" screws (C) provided.

SAFETY WARNING: READ WIRING AND GROUNDING INSTRUCTIONS (I.S. 18) AND ANY ADDITIONAL DIRECTIONS. TURN POWER SUPPLY OFF DURING INSTALLATION. IF NEW WIRING IS REQUIRED, CONSULT A QUALIFIED ELECTRICIAN OR LOCAL AUTHORITIES FOR CODE REQUIREMENTS.

3

Make electrical connections from supply wire to fixture lead wires. Refer to instruction sheet (I.S. 18) and follow all instructions to make all necessary wiring connections. Then refer back to this sheet to continue installation of this fixture.

4

1. To mount fixture, slip the two mounting screws (B) through the two mounting holes (D) in the backplate (E) - see **Drawing 1**.
2. While holding fixture in place, thread the two ball knobs (F) on to the end of the mounting screws (B), and tighten.

5

1. Fixture can now be lamped accordingly.
2. The glass in this fixture is installed by lining up the grooves (3) in the glass with the tabs located inside the roof (1) - see **Drawing 1**.
3. To install glass (2) align grooves and slip glass up into roof. Turn glass to lock it in place.

Note: Maximum wattage for 2080 fixture is 100 watts per bulb.

6.01.11