

Family: Atlantis | Item No. 1649

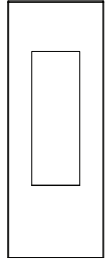

**Drawing 1 - Fixture Mounting**

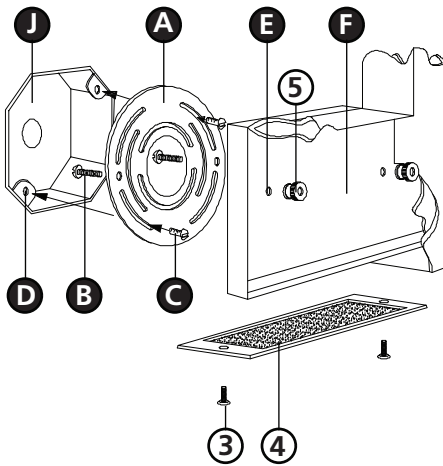

## ▼ start here

**1**

1. Find a clear area in which you can work.
2. Unpack fixture and glass from carton.
3. Carefully review instructions prior to assembly.

**\*\*\* The construction of this fixture will be accomplished by first attaching the mounting strap to the junction box, making all necessary electrical connections, mounting the fixture to the wall, and then lamping the fixture.**

**2**

1. Prepare mounting strap (A) by threading the two 8-32 x 1 mounting screws (B) into the back of the mounting strap (A) - see **Drawing 1**.
  - Be sure the holes into which the screws are threaded match the spacing of holes (E) in the backplate (F).
2. Attach mounting strap (A) to junction box (J) by threading 2 screws (C) provided into holes (D) of junction box (J).
3. Un-thread the 2 screws (3) from the bottom lens cover (4) and remove lens cover (4).

**SAFETY WARNING: READ WIRING AND GROUNDING INSTRUCTIONS (I.S. 18) AND ANY ADDITIONAL DIRECTIONS. TURN POWER SUPPLY OFF DURING INSTALLATION. IF NEW WIRING IS REQUIRED, CONSULT A QUALIFIED ELECTRICIAN OR LOCAL AUTHORITIES FOR CODE REQUIREMENTS.**

**3**

Make electrical connections from supply wire to fixture lead wires. Refer to instruction sheet (I.S. 18) and follow all instructions to make all necessary wiring connections. Then refer back to this sheet to continue installation of this fixture.

**4**

1. To mount fixture, line up holes (E) in backplate (F) and slide fixture over both 8-32 x 1 screws (B) - see **Drawing 1**.
2. While holding fixture in place, thread the two 8-32 battery nuts (5) provided onto screws (B) and tighten with pliers.

**5**

1. Bottom of fixture can now be lamped accordingly.
2. Re-place bottom lens cover (4) and secure with the 2 screws (3) - see **Drawing 1**.
3. To lamp top of fixture. remove lens cover (4) by un-threading 2 screws (3).
4. Top of fixture can now be lamped accordingly.
5. Replace lens cover and secure with the 2 screws (3).

Note: Maximum wattage for the 1649 is GU-10, 20 watt MR-16

2.7.08